

WORLD MARKET®

Assembly Instructions

Russo Writing Desk SKU 632939, 632940

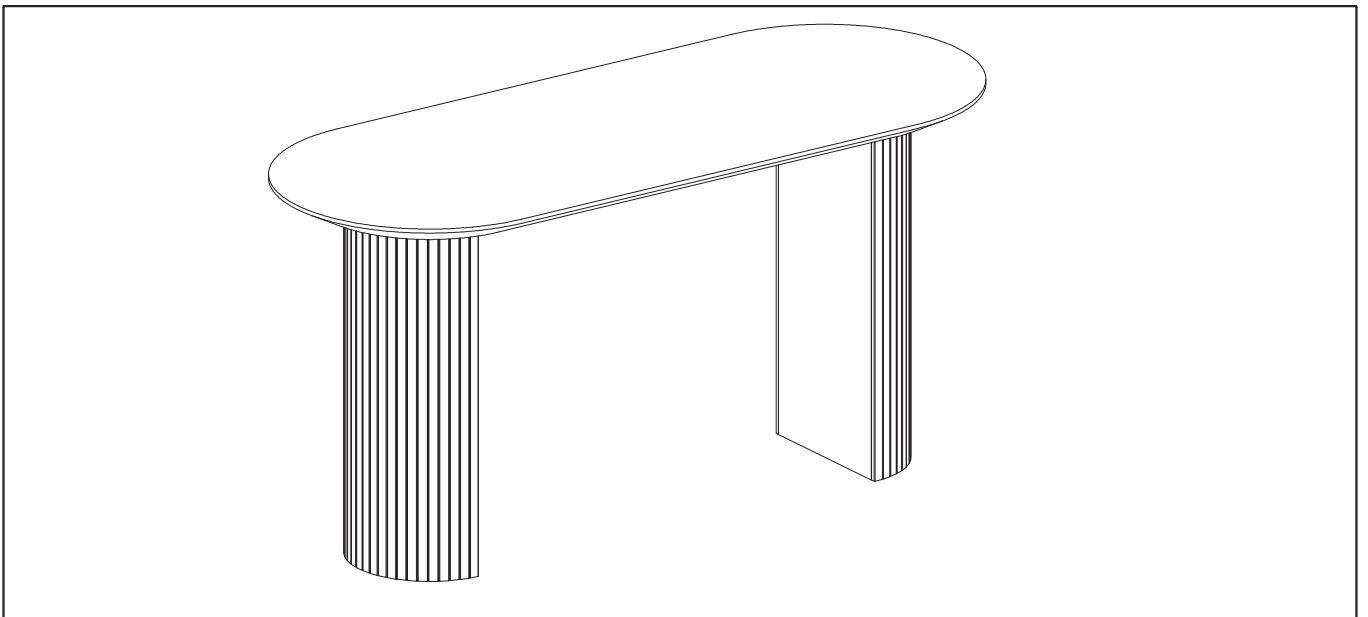



Thank you for your purchase. If you have any questions pertaining to the assembly of this furniture piece, please contact the nearest World Market store. If you are not near a store, please call our customer service call center toll free at 877-967-5362 for assistance.

ALL PRODUCTS SOLD AT WORLD MARKET ARE NOT
FOR COMMERCIAL USE AND ARE INTENDED FOR
RESIDENTIAL USE ONLY.

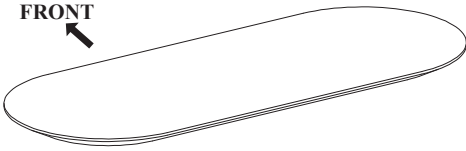
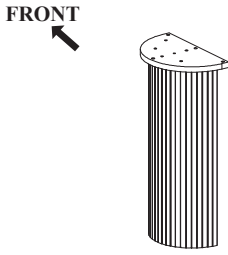
Component List

LABEL	PICTURE	DESCRIPTION	QTY.
A		Top Table	1
B		Leg Frame	2

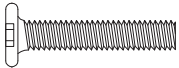
Hardware List

LABEL	DESCRIPTION	QTY.
H-1	 Dowel Ø10 x 30mm	2
H-2	 Allen Bolt M8 x 40mm	8
H-3	 Spring Washer Ø8 x Ø14 x 2mm	8
H-4	 Flat Washer Ø8 x Ø20 x 2mm	8

Tool List

LABEL	DESCRIPTION	QTY.
T-1	 Allen Key M4 x 30 x 110mm	1

Assembly Preparation

Before Beginning:

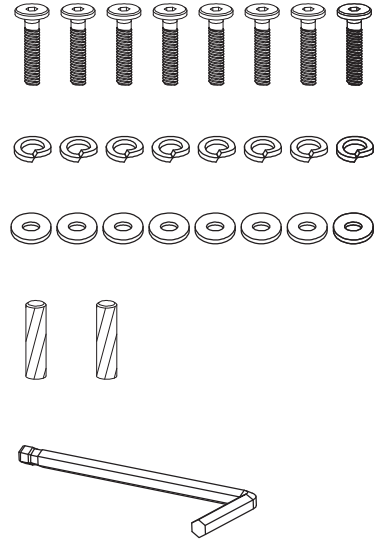
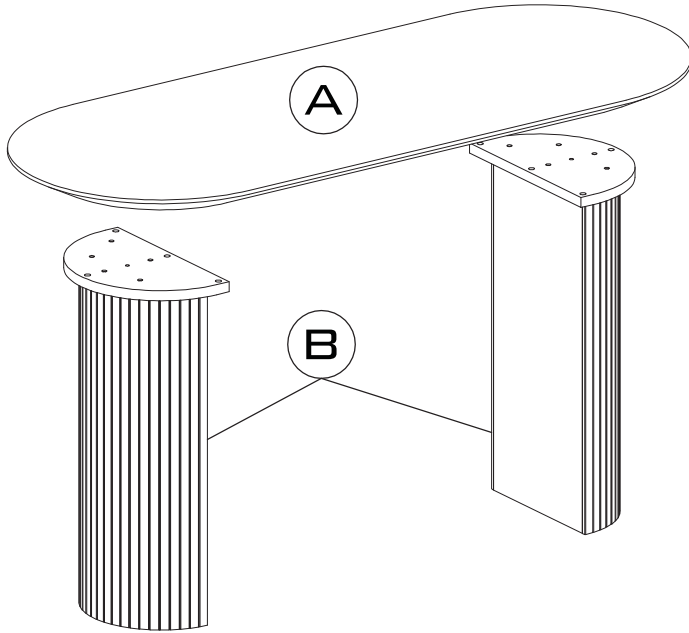

Unpack all hardware bags and components to ensure you have all parts. Take note of bolt hardware size differences and components that may have directional labels (Example: TOP or FRONT).



Read the assembly instructions, cover-to-cover. Save any **Care and Maintenance** instructions pages for after the assembly has been completed.



It is always recommended to have 2 adults on hand for assembly.



Do not assemble on hard, abrasive flooring or carpeted surfaces that can damage or get caught in the components during assembly.

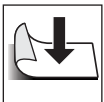

Assemble on a clean non-marring surface (such as the product's packing foam).



Do not discard any packaging until the product has been fully assembled.



In case of missing parts, please contact your nearest World Market store or call our customer service call center at 1-877-967-5362.



WARNING: Small parts are a choking hazard. Adult supervision is required before, during, and after

Assembly Steps

Step 1

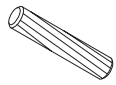

(H-1) Dowel x 2

TOP



A

H-1

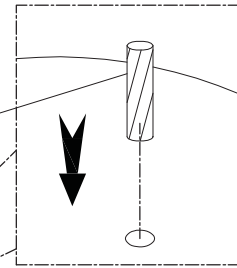

Make sure Dowel are fully as shown.

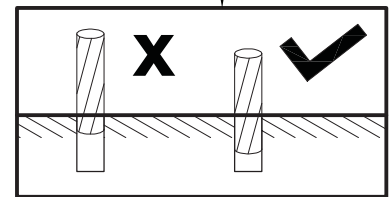

Using a second person to assist you, carefully place the Table Top (A) upside down onto a padded, non-marring surface. Insert Dowels (H-1) into the center of each circular support on the bottom of the Table Top (A).

Step 2

TOP



B

A

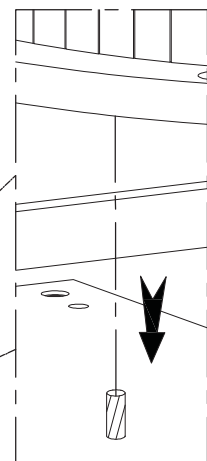

Using a second person to assist you, position the Leg Frame (B) upside down, and align the corresponding hole with the previously installed Dowel (H-1). Lower the Leg Frame (B) onto the Table Top (A) and align the through holes in the Leg Frame (B) with the threaded inserts in the Table Top (A).

Assembly Steps

Step 3

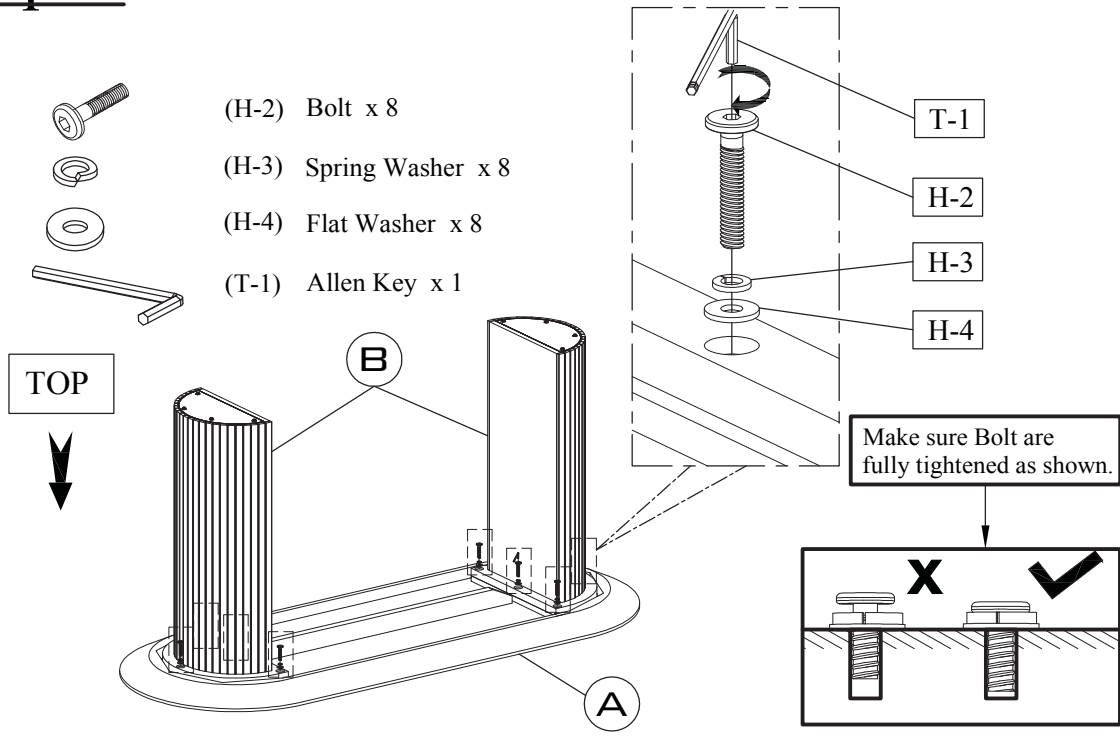

Secure the Leg Frames (B) to the Table Top (A) by first engaging all Allen Bolts (H-2), Spring Washers (H-3), and Flat Washers (H-4), stacking the hardware in the order as shown. Once all are engaged, fully tighten using the provided Allen Key (T-1). Do not over tighten.

Step 4

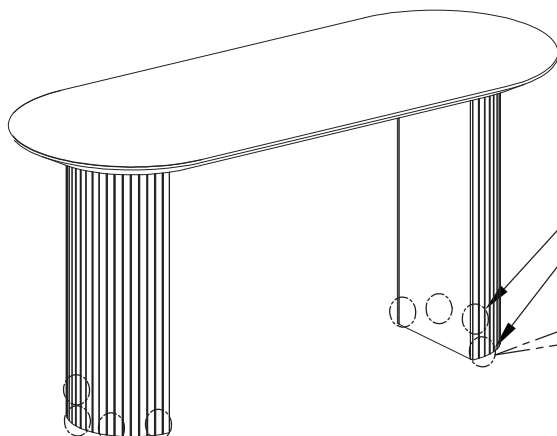

Levelers are located on the bottom of each leg and may be used for additional adjustment if needed for uneven surfaces.

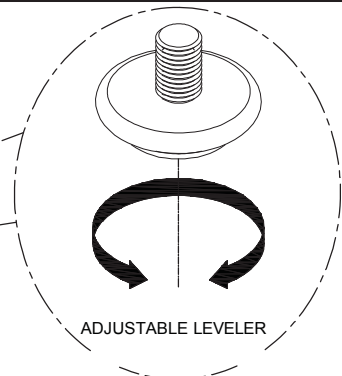

Assembly is now complete and the product is ready for use. Adjustable levelers are located on the bottom of each leg and may be adjusted by turning outwards, counter-clockwise to help account for uneven surfaces. NOTE: Hardware may loosen over time. Periodically check that all connections remain tight and adjust as needed.

Warnings



All products sold at World Market are not for commercial use and are intended for residential use only.

Care & Maintenance



DO NOT put hot items directly on furniture surface.



DO NOT clean furniture with harsh cleansers or polish.



DO NOT place furniture in direct sunlight.



DO NOT place furniture near heating or cooling vents.



DO NOT write on furniture without a padded barrier to protect the surface.



DO NOT place furniture outside. For INDOOR USE ONLY.



Dust and pick up spills using a clean, non-colored, lint-free dry cloth.

NOTE: It is recommended to use coasters to protect the table top.

WORLD MARKET LIMITED ONE-YEAR WARRANTY – Indoor Furniture

For your customer satisfaction, this product carries a LIMITED ONE-YEAR WARRANTY from the date of delivery. This limited warranty only applies to World Market brand furniture, and not to other furniture brands sold on World Market's website.

Where applicable, the limited warranty provides coverage for:

1. **Manufacturing, Material and Workmanship Defects:** Includes defects related to core frame/structure substrates (wood and metal); cracking, splitting, or complete breakage of hardwood, plywood or medium density fiberboard (MDF); cracking, splitting or lifting of wood veneer or laminated top surfaces caused by process failure; broken welds or improperly coated metal frame components (powder coating or painted); fabric or leather material defects including tears, misprints, fraying, crease marks, skip stitches or open seams; support webbing material and sinuous spring defects or damage, including method of attachment to frame; and other component failures that are a direct result of manufacturing or workmanship defects.
2. **Cushions & Cushions with Enclosed Steel Pocket Coils:** Failed or ruptured steel pocket coils enclosed inside of seat cushions, or loss of resiliency from a material breakdown of foam or fiber filling, which should not be confused with softening or settling during normal use.
3. **Leather:** Splitting or cracking of leather material. NOTE: The warranty does NOT cover natural hide markings, variations in the leather color or grain due to the authentic natural properties of processed cowhide leather.
4. **Bonded Leather or Bi-cast Leather:** Separation of the polyurethane coating, peeling or cracking of the inner layer or at the bonded seam edges (bi-cast straps).
5. **Furniture Components (Hardware & Mechanisms):** Includes defects to pre-installed components or hardware provided to the customer for assembly such as office chair hydraulic lifts, lift mechanisms, metal bases and casters, swivel plate mechanisms; for drawers, metal glides, handles/knobs; for doors, hinges, magnetic latches; and other components such as bent or stripped threaded leg posts and adjustable levelers. For missing, damaged, corroded, or misplaced hardware components such as bolts or washers, please contact Customer Service at: 877-967-5362.

This LIMITED ONE-YEAR WARRANTY does NOT cover:

1. Damage due to mishandling during transportation from store or transportation without original protective packaging.
2. Abuse, negligence (product misuse) or wear and tear that may result in or from:
 - a. **Wood & Veneer:** Mishandling, exposure to moisture, peeling or discoloration caused by exposure to moisture or excessive sunlight, heat; splintered, dented or nicked panels, legs or component edges or paint/finish blemishes; or treatment with corrosive chemicals (dyes, inks, paints or harsh cleaning products).
 - b. **Fabric & Leather (Including Bonded or Bi-Cast Leathers):** cuts, punctures, tears, burns, pet damage, or treatment with corrosive chemicals (dyes, inks, paints or harsh cleaning products), exposure to direct sunlight, fire, high heat, water, or any bright light source (natural or artificial) that may cause splitting, peeling or flaking with time.
 - c. **Foam (Cushions):** Flattening, relaxing or settling/softening of foam components that comes with normal use.
 - d. **Hardware Components:** improper installation or misuse/substitution of hardware components not defined in the Assembly Instructions for the product (if applicable)
3. Damage due to environmental exposure to direct sunlight, fire, high heat, water or extreme humidity, any bright light source (natural or artificial), or any environment that the product is not intended for.
4. This warranty is applicable for indoor furniture products purchased for residential use only.

For additional information on returns, please visit: <https://www.worldmarket.com/category/customer-service/returns.do>

All products sold at World Market are NOT FOR COMMERCIAL USE and are intended for residential use only. Products purchased for commercial use will VOID all warranty provisions as listed above.

Any claims under this LIMITED ONE-YEAR WARRANTY are valid and applicable only as to the original purchaser and must be accompanied by proof of purchase. Warranty claims should be submitted to a World Market store or through World Market Customer Service Call Center, Toll Free at 877-967-5362.

For valid warranty claims, World Market will repair or replace the product, or offer a full or partial credit, in the sole discretion of World Market. This LIMITED ONE-YEAR WARRANTY gives you specific legal rights and you may also have other rights which vary from state to state.